

## Schutzbügel BMW R 1200 GS '08 – Crash Bar BMW R 1200 GS '08 –

### Montagehinweise

Alle vom Motorrad gelösten Schrauben sind gemäß Herstellerangaben wieder zu montieren, oder mit von SW-MOTEC gelieferten Schrauben zu ersetzen. Falls nicht anderweitig definiert, diese Schrauben nach Tabelle anziehen.

<b>M6</b>	<b>9,6 Nm</b>
<b>M8</b>	<b>23 Nm</b>
<b>M10</b>	<b>46 Nm</b>
<b>M12</b>	<b>79 Nm</b>

Gegebenenfalls Schrauben mit flüssiger Schraubensicherung einkleben.

Prüfen Sie nach 50 km alle Verbindungen auf festen Sitz.

### Mounting Instructions

SW-MOTEC products should be installed by a qualified, experienced motorcycle technician. If you are unsure of your ability to properly install a product, please have the product installed by your local motorcycle dealer. SW-MOTEC takes no responsibility for damages caused by improper installation.

All screws, bolts and nuts, including all replacement hardware provided by SW-MOTEC, should be tightened to the torque specified in the OEM maintenance manual for your motorcycle. If no torque specifications are provided in the OEM maintenance manual, the following torques may be used:

<b>M6</b>	<b>9,6 Nm</b>
<b>M8</b>	<b>23 Nm</b>
<b>M10</b>	<b>46 Nm</b>
<b>M12</b>	<b>79 Nm</b>

All screws, bolts and nuts should be checked after driving the first 50 km to ensure that all are tightened to the proper torque.

Medium strength liquid thread-locker (i.e., "Loctite") should be used to secure all screws, bolts and nuts.

SW-MOTEC GmbH & Co. KG  
Bahnhofstrasse 44d  
35282 Rauschenberg  
-Germany-

Tel.: ++ 49 (0) 6425 816 800  
Fax: ++ 49 (0) 6425 816 810

[www.sw-motech.com](http://www.sw-motech.com)

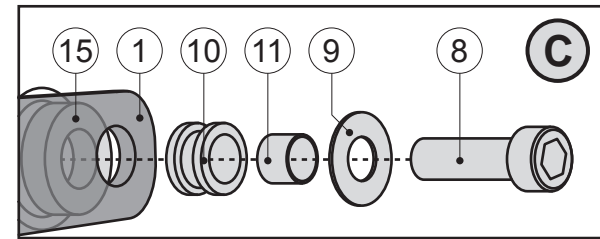

Linke Seite / left side

5 7

6

1

**!** Befestigungspunkt (A): Auf der rechten Seiten Schraube (16), Unterlegscheibe (17) und Distanzbuchse (18) benutzen .  
 Fixing point (A): Use screw (16), washer (17) and spacer (18) to attach the crash bar to the right side .

12 13 1 14

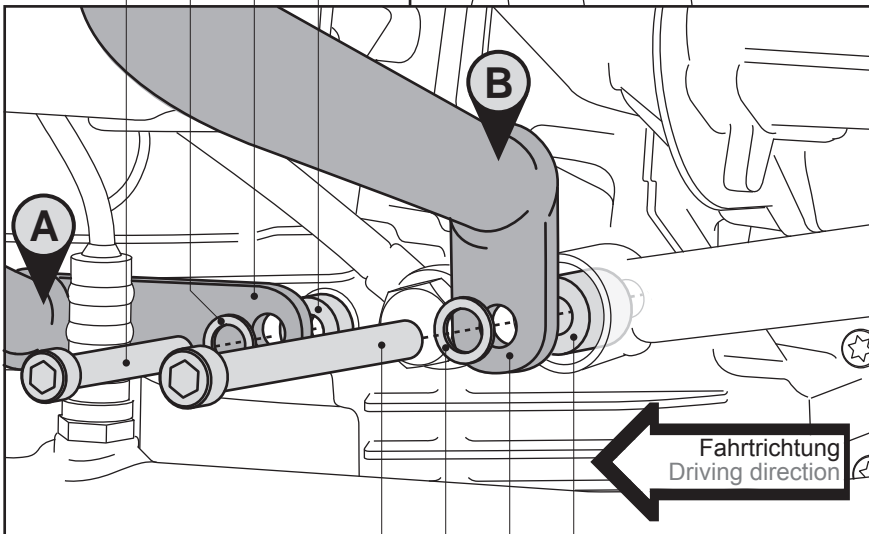

Fahrtrichtung  
 Driving direction

2 3 1 4

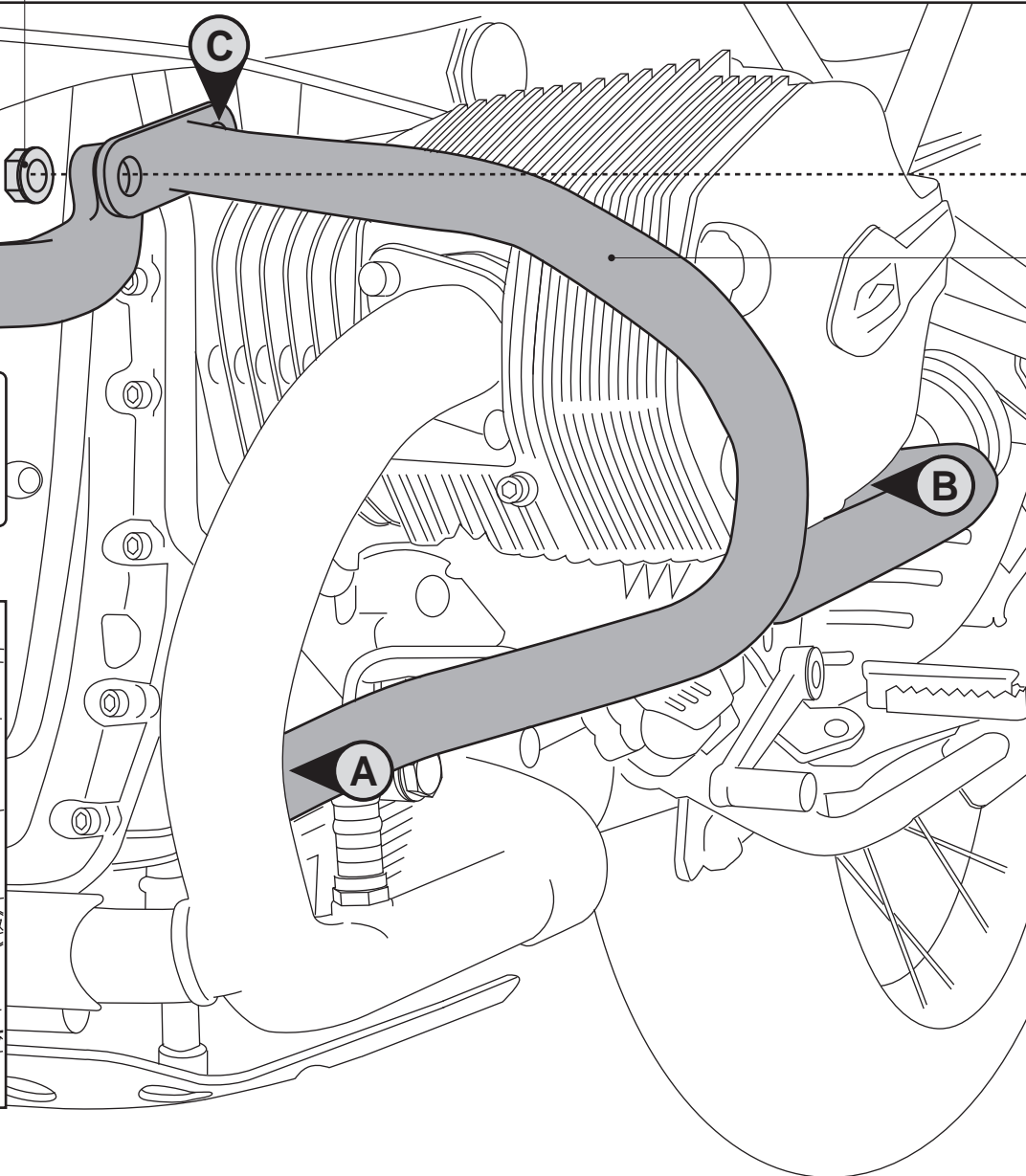

1 Schutzbügel  
Crash Bar



SBL.07.562.901/902 **00**

Anzahl/ Pcs. 2 (L/R)

5 Querverbinder  
Cross Bar



SBL.07.312.003 **00**

Anzahl/ Pcs. 1

8 Innensechskantschraube  
Hexagon Socket Screw



M6 x 25 DIN 912

Anzahl/ Pcs. 2

12 Innensechskantschraube  
Hexagon Socket Screw



Linke Seite / left side  
M10 x 40 DIN 912

Anzahl/ Pcs. 1

16 Innensechskantschraube  
Hexagon Socket Screw



Rechte Seite / right side  
M10 x 35 DIN 912

Anzahl/ Pcs. 1

2 Innensechskantschraube  
Hexagon Socket Screw



M12 x 80 DIN 912

Anzahl/ Pcs. 2

6 Linsenkopfschraube  
Lenshead Screw



M8 x 25 DIN 7380

Anzahl/ Pcs. 2

9 Unterlegscheibe  
Washer



A 6,4 DIN 9021

Anzahl/ Pcs. 2

13 Unterlegscheibe  
Washer



A 10,5 DIN 125

Anzahl/ Pcs. 1

17 Unterlegscheibe  
Washer



A 10,5 DIN 125

Anzahl/ Pcs. 1

3 Unterlegscheibe  
Washer



A 13 DIN 125

Anzahl/ Pcs. 2

7 Mutter mit Bund,  
selbstsichernd  
Lock Nut with Flange



M8 DIN 6927

Anzahl/ Pcs. 2

10 Gummitülle  
Rubberelement



12H3476

Anzahl/ Pcs. 2

14 Distanzbuchse  
Spacer



Da:20 Da:10,5 h:10

Anzahl/ Pcs. 1

18 Distanzbuchse  
Spacer



Da:20 Da:10,5 h:6

Anzahl/ Pcs. 1

4 Distanzbuchse  
Spacer



Da:25 Di:12,5 h:28

Anzahl/ Pcs. 2

11 Distanzbuchse  
Spacer



Da:8 Di:6,4 h:10

Anzahl/ Pcs. 2

15 Distanzbuchse  
Spacer



Da:16 Di:6,4 h:5

Anzahl/ Pcs. 2