

QUICK-LOCK EVO-Träger
QUICK-LOCK EVO-Carrier

KTM LC 8
KTM LC 8

Montagehinweise

Fahren Sie nicht ohne Koffer mit montierten Seitenplatten. Wenn sie ohne Gepäck fahren, Seitenplatten demontieren.

Alle vom Motorrad gelösten Schrauben sind gemäß Herstellerangaben wieder zu montieren, oder mit von SW-MOTECH gelieferten Schrauben zu ersetzen. Falls nicht anderweitig definiert, diese Schrauben nach Tabelle anziehen.

M6	9,6 Nm
M8	23 Nm

Gegebenenfalls Schrauben mit flüssiger Schraubensicherung einkleben.

Prüfen Sie nach 50 km alle Verbindungen auf festen Sitz.

Max. Zuladung 5 Kg pro Koffer.

Mounting Instructions

German safety regulations require that no metal edge with a radius of less than 2.5mm be exposed while driving a motorcycle. Because Quick-Lock sidecase racks have edges with a radius of less than 2.5mm, Quick-Lock sidecase racks should not be used when luggage is not attached to them.

SW-MOTECH products should be installed by a qualified, experienced motorcycle technician. If you are unsure of your ability to properly install a product, please have the product installed by your local motorcycle dealer. SW Motech takes no responsibility for damages caused by improper installation.

All screws, bolts and nuts, including all replacement hardware provided by SW-MOTECH, should be tightened to the torque specified in the OEM maintenance manual for your motorcycle. If no torque specifications are provided in the OEM maintenance manual, the following torques may be used:

M6	9,6 Nm
M8	23 Nm

All screws, bolts and nuts should be checked after driving the first 50 km to ensure that all are tightened to the proper torque.

Medium strength liquid thread-locker (i.e., "Loctite") should be used to secure all screws, bolts and nuts.

Max. Load 5 Kg (11 lbs) per case.

SW-MOTECH GmbH & Co. KG
Bahnhofstrasse 44d
35282 Rauschenberg
-Germany-

Tel.: ++ 49 (0) 6425 816 800
Fax: ++ 49 (0) 6425 816 810

www.sw-motech.com

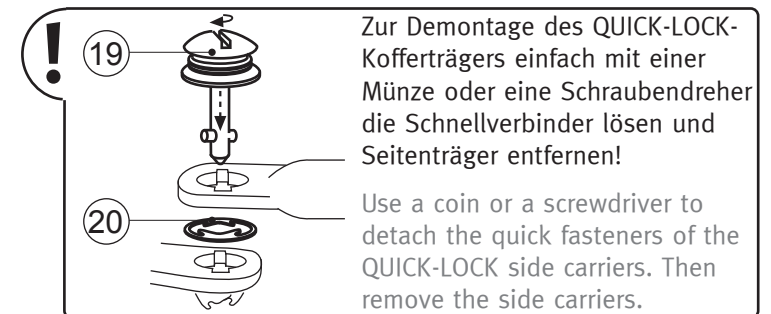

1 EVO-Träger
EVO-Carrier

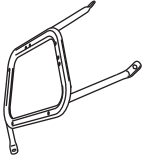

KFT.04.262.961/962

Anzahl/ Pcs. 2 (L/R)

5 Befestigungsblech
Fixing Lug



KFT.00.077.004 01

Anzahl/ Pcs. 2

8 Querverbinder
Cross Girder



KFT.04.262.002 00

Anzahl/ Pcs. 1

12 Distanzbuchse
Spacer



Da:20 Di:8,4 h:13

Anzahl/ Pcs. 2

15 Querverbinder
Cross Girder



KFT.00.064.003 06

Anzahl/ Pcs. 1

19 Schnellverschluss
mit Federscheibe
Quick Fastener

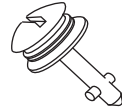

CAM.2312S21-12AHNV

Anzahl/ Pcs. 8

2 Befestigungsblech
Fixing Lug

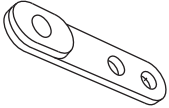

KFT.04.262.001 00

Anzahl/ Pcs. 2 (L/R)

6 Senkkopfschraube
Countersunk Screw

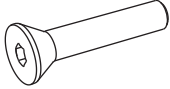

schwarz/black

M8 x 70 DIN 7991

Anzahl/ Pcs. 2

9 Senkkopfschraube
Countersunk Screw

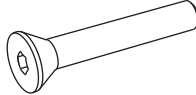

schwarz/black

M8 x 80 DIN 7991

Anzahl/ Pcs. 2

13 Formscheibe
Moulding



schwarz/black

SE.00.8,4.02

Anzahl/ Pcs. 2

16 Sechskantschraube
Hexagon Screw

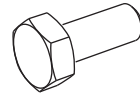

M6 x 20 DIN 933

Anzahl/ Pcs. 2

20 Sicherungsring
Retaining Ring

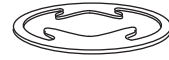

CAM.23.12S.10-1BP

Anzahl/ Pcs. 8

3 Innensechskant-
schraube, flacher Kopf
Hexagon Socket Screw,
flat Head

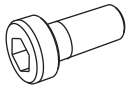

M8 x 20 DIN 6912

Anzahl/ Pcs. 4

7 Distanzbuchse
Spacer



Da:13 Di:8,4 h:10

Anzahl/ Pcs. 2

10 Senkkopfschraube
Countersunk Screw

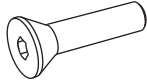

schwarz/black

M8 x 60 DIN 7991

Anzahl/ Pcs. 2

14 Formteil
Moulding



KFT.04.262.003 00

Anzahl/ Pcs. 2

17 Unterlegscheibe
Washer



A 6,4 DIN 125

Anzahl/ Pcs. 2

4 Unterlegscheibe
Washer



A 8,4 DIN 125

Anzahl/ Pcs. 4

11 Distanzbuchse
Spacer



Da:20 Di:8,4 h:9

Anzahl/ Pcs. 2

18 Mutter mit Bund,
selbstsichernd
Lock Nut with Flange



schwarz/black

M6 DIN 6927

Anzahl/ Pcs. 2

! Achtung: Bei Benutzung der Original Top Case-Platte müssen anstelle der Distanzbuchsen (12) die Formscheiben (13) benutzt werden und anstelle der Distanzbuchsen (11) die Formteile (14).

Attention: If you mount the original Top Case plate, use the mouldings (13) instead the spacers (12) and the mouldings (14) instead the spacers (11).

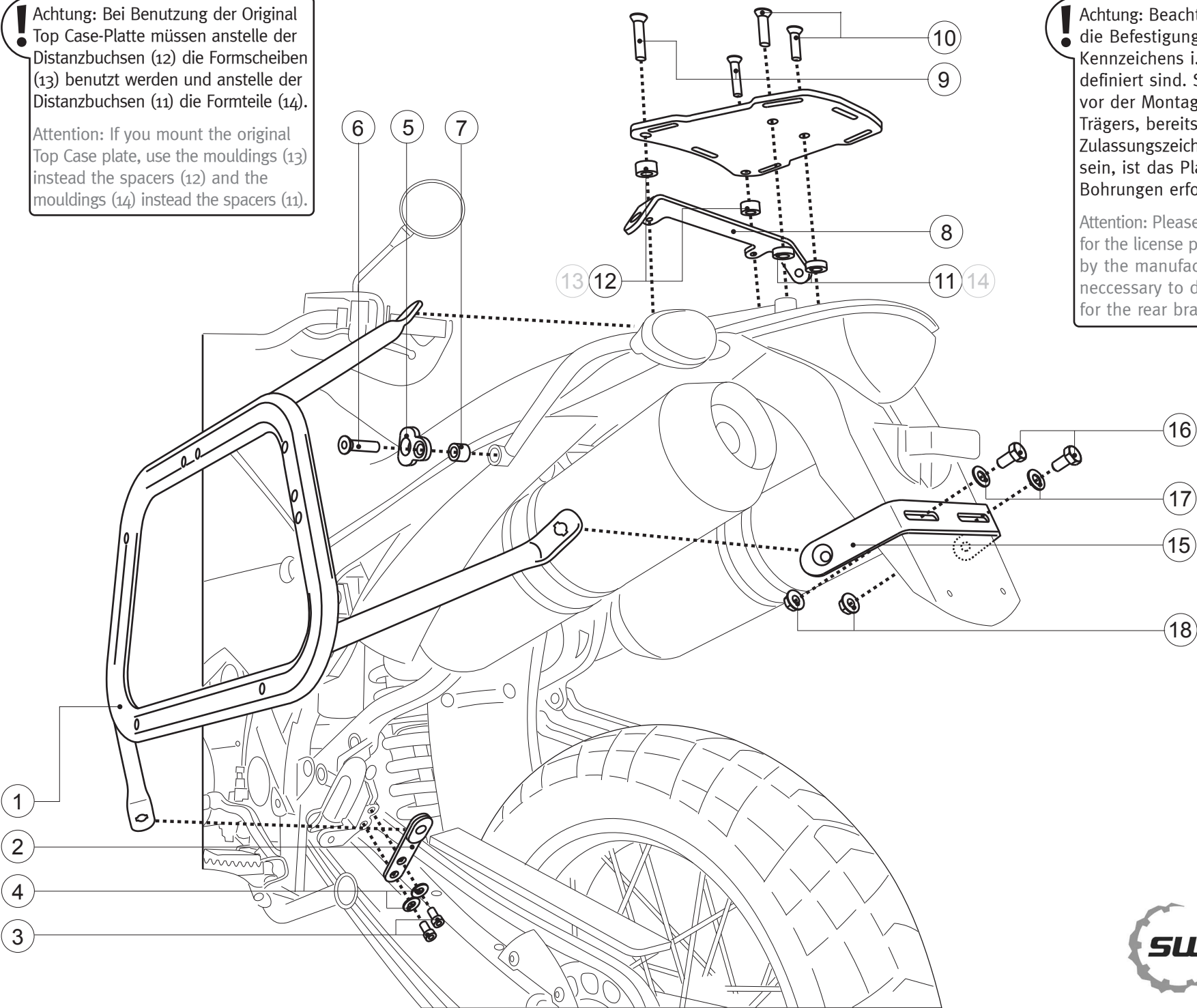

! Achtung: Beachten Sie bitte, dass die Befestigungsbohrungen des Kennzeichens i.d.R werkseitig nicht definiert sind. Sollte Ihr Fahrzeug vor der Montage des QUICK-LOCK Trägers, bereits mit einem Zulassungszeichen versehen worden sein, ist das Platzieren neuer Bohrungen erforderlich.

Attention: Please note, that the holes for the license plate are not specified by the manufacturer. So it will be necessary to drill new screw holes for the rear bracket.