

BMW F650 CS

Alle vom Motorrad gelösten Schrauben sind gemäß Herstellerangaben wieder zu montieren, oder mit von SW-MOTECH gelieferten Schrauben zu ersetzen. Falls nicht anderweitig definiert, diese Schrauben nach Tabelle anziehen.

M6	9,6 Nm
M8	23 Nm
M10	46 Nm

Gegebenenfalls Schrauben mit flüssiger Schraubensicherung einkleben.

Prüfen Sie nach 50 km alle Verbindungen auf festen Sitz.

Die Kurvenfreiheit kann durch einen Hauptständer eingeschränkt werden

Centerstand cornering clearance:
SW-MOTECH centerstands are carefully designed and tested to eliminate reductions in cornering clearance and ground clearance under most driving conditions on an unmodified stock motorcycle, and are certified to be compliant with European ABE safety standards. Use of any centerstand may reduce cornering clearance or ground clearance under extreme driving situations.







SW-MOTECH products should be installed by a qualified, experienced motorcycle technician. If you are unsure of your ability to properly install a product, please have the product installed by your local motorcycle dealer. SW-MOTECH takes no responsibility for damages caused by improper installation.

All screws, bolts and nuts, including all replacement hardware provided by SW-MOTECH, should be tightened to the torque specified in the OEM maintenance manual for your motorcycle. If no torque specifications are provided in the OEM maintenance manual, the following torques may be used:

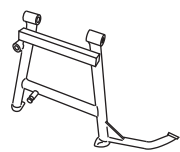
M6	9,6 Nm
M8	23 Nm
M10	46 Nm

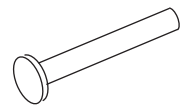
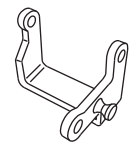
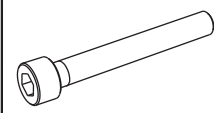
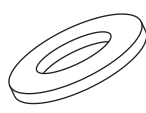
All screws, bolts and nuts should be checked after driving the first 50 km to ensure that all are tightened to the proper torque.

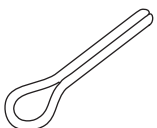
Medium strength liquid thread-locker (i.e., "Locktite") should be used to secure all screws, bolts and nuts.

<p>1 Hauptständer Centre Stand</p>  <p>HPS.07.212.900 Anzahl/ Pcs. 1</p>	<p>5 Zugfedersatz Spring-Set</p>  <p>ZFD.00.150.008 Anzahl/ Pcs. 1</p>	<p>9 Steckachse Axle</p>  <p>HPS.07.212.003 Anzahl/ Pcs. 1</p>
<p>2 Hauptständer-Traverse Centre Stand Bracket</p>  <p>HPS.07.212.904 Anzahl/ Pcs. 1</p>	<p>6 Zylinderschraube mit Innensechskant Hexagon Socket Screw</p>  <p>M10 x 110 DIN 912 Anzahl/ Pcs. 1</p>	<p>10 Unterlegscheibe Washer</p>  <p>A 13 DIN 125 Anzahl/ Pcs. 1</p>
<p>3 Federumlenkung Spring bracket</p>  <p>HPS.07.212.001 Anzahl/ Pcs. 1</p>	<p>7 Unterlegscheibe Washer</p>  <p>A 10,5 DIN 125 Anzahl/ Pcs. 1</p>	<p>11 Splinte Retaining Pin</p>  <p>3.2 x 25 DIN 94 Anzahl/ Pcs. 1</p>
<p>4 Gummianschlag Rubber Element</p>  <p>MSS.00.003.016 Anzahl/ Pcs. 1</p>	<p>8 Distanzbuchse Spacer</p>  <p>Da=20 Di=10,3 h=6 Anzahl/ Pcs. 1</p>	

SW-MOTECH GmbH & Co. KG
Bahnhofstrasse 44d
35282 Rauschenberg
-Germany-

Tel.: ++ 49 (0) 6425 816 800
Fax: ++ 49 (0) 6425 816 810

www.sw-motech.com

1. Rahmenunterzug mit dem daran befindlichen Seitenständer demontieren.
2. Die Hauptständer-Traverse (2) zusammen mit dem Rahmenunterzug montieren. Dabei zum Ausgleich am vorderen Montagepunkt die Distanzbuchse (8) mit der original Schraube montieren.
3. Seitenständer montieren.

Achtung: Bitte Beachten Sie beim Entfernen der Original Schraube am Umlenksystem des Federbeins folgenden Punkt:

- Entlasten Sie unbedingt die Heckschwinge Ihres Motorrads, am besten durch Anheben des Hecks durch einen Helfer.

1. Remove side stand with frame bracket.
2. Mount the centre stand bracket (2) together with the side stand. Use spacer (8) at the front attachment point to equalize the space.
3. Attach the side stand.

Attention: Please pay attention to the following, when removing the original spring leg screw:

- support the motorcycle and the rear wheel so all weight is removed from the swing arm.

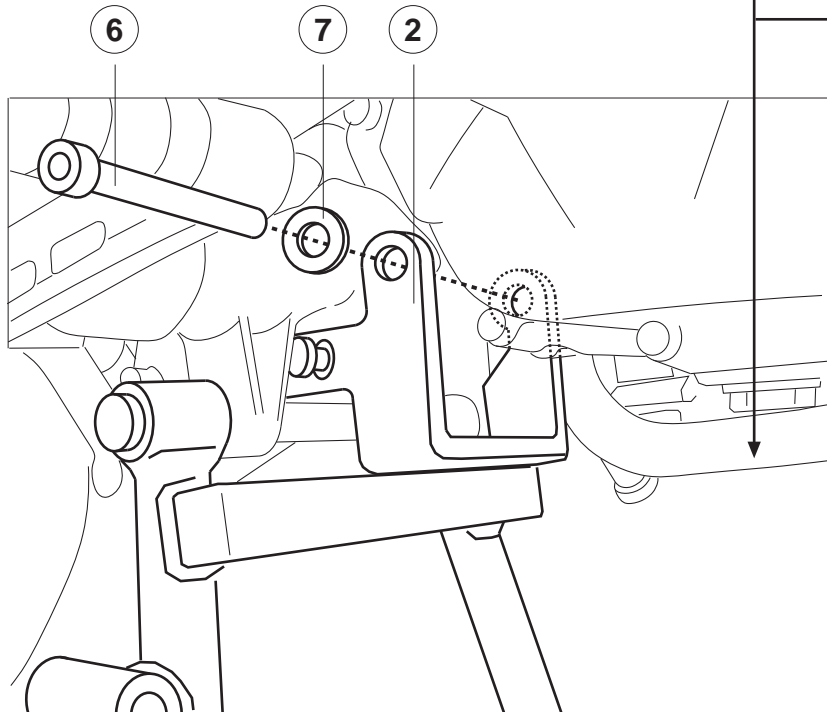
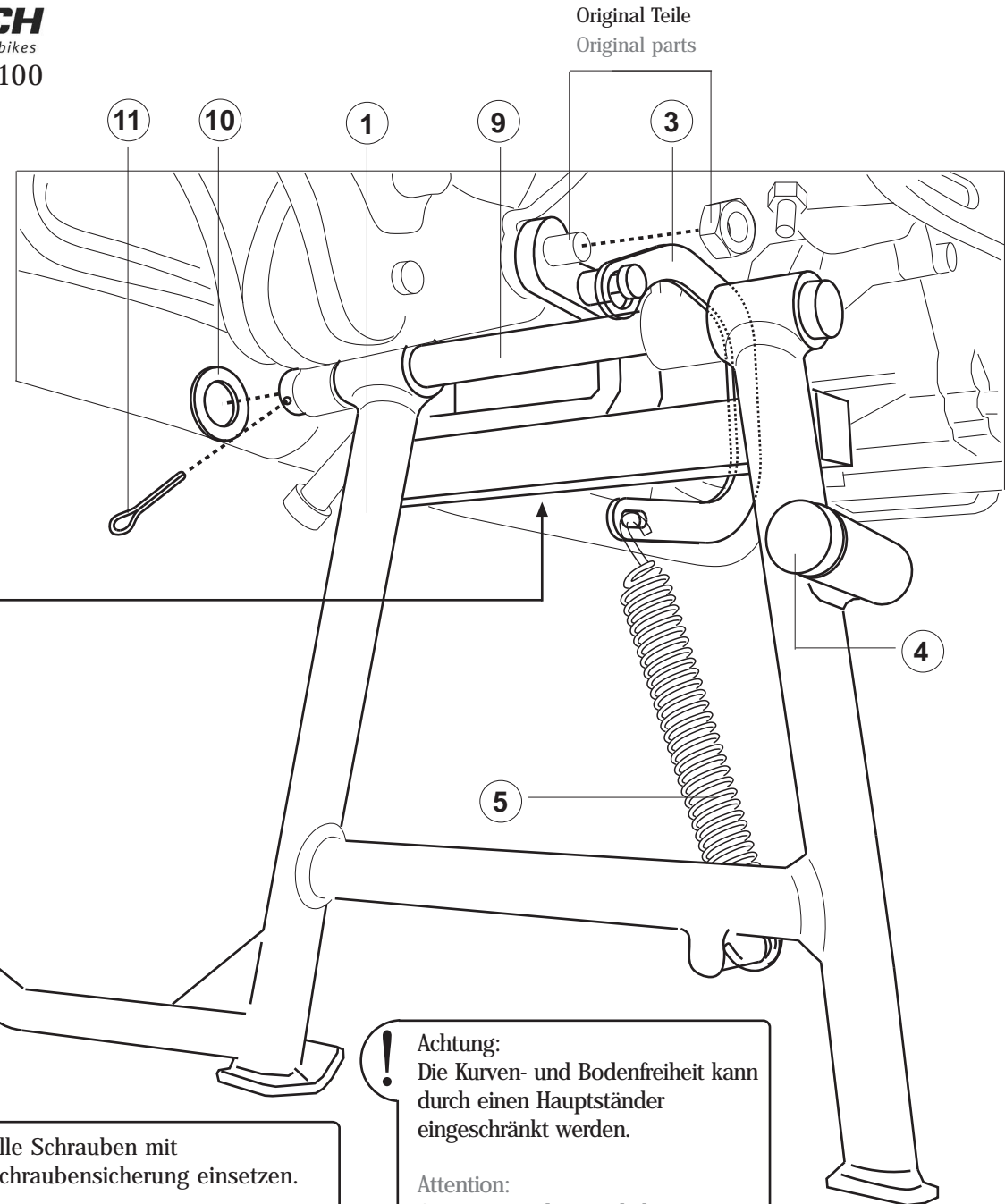
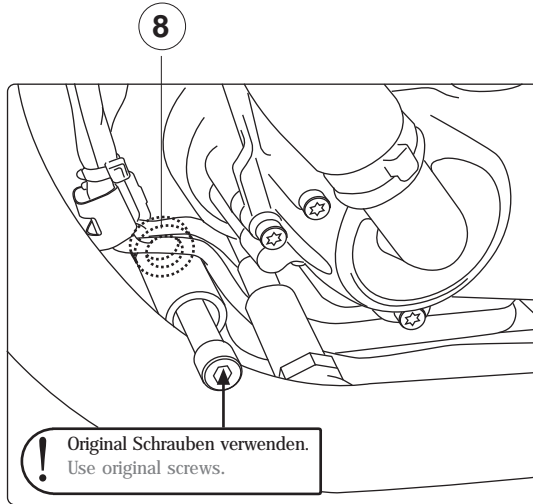

! Alle Schrauben mit Schraubensicherung einsetzen.
 Insert all screws with retainer.

! Achtung:
 Die Kurven- und Bodenfreiheit kann durch einen Hauptständer eingeschränkt werden.
 Attention:
 Cornering and ground clearance can be reduced by using a centre stand.